

General specifications	
Spa weight (dry)	257 Kg
Spa weight (filled)	1232 Kg
Package dimension	1150x2270x2180mm
Package weight	333 Kg

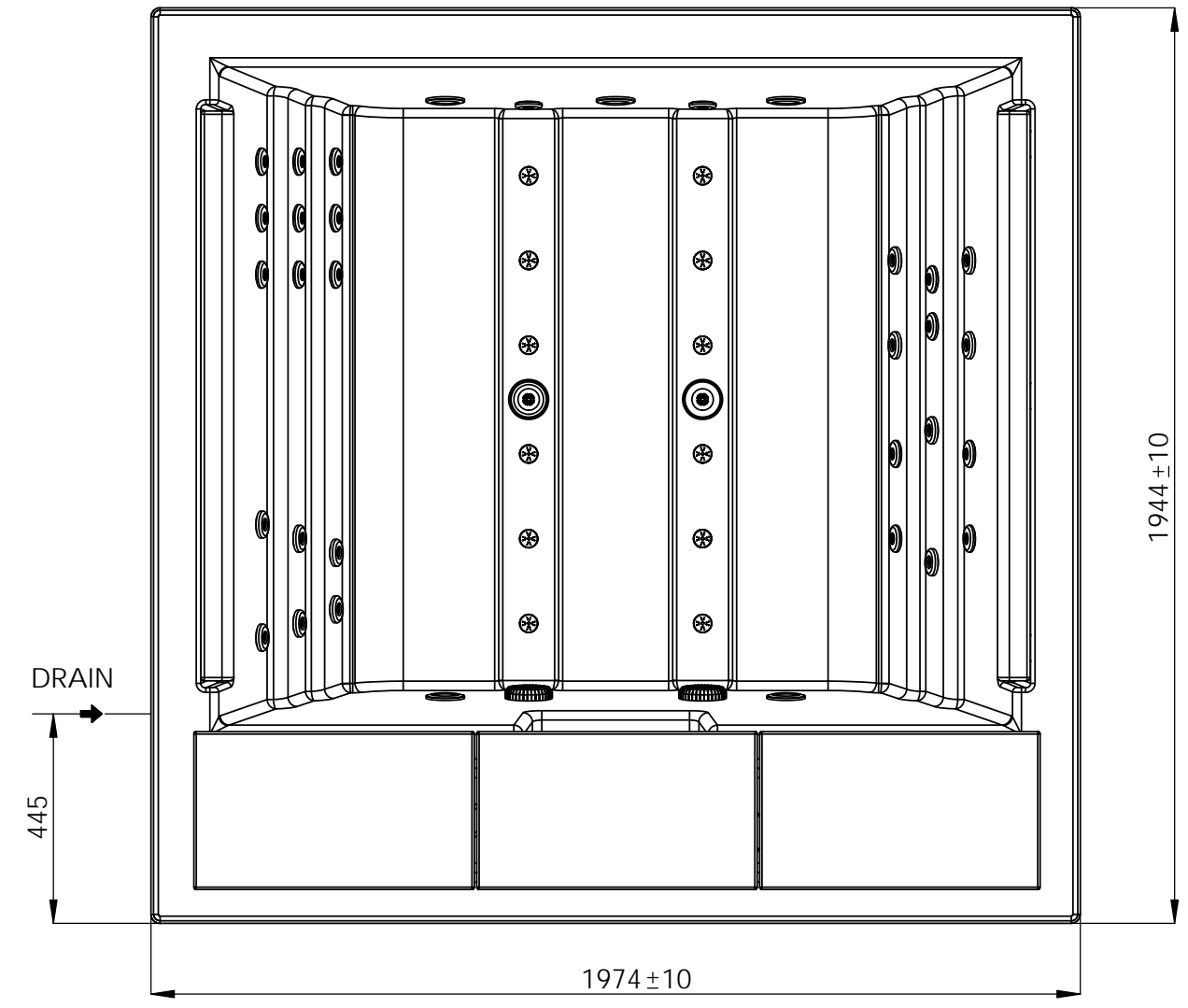

**Inground option**

**WARNING:**  
It's essential to keep a minimum clearance access of **700mm** all around.  
Minimum depth of spa hole **690 mm**.

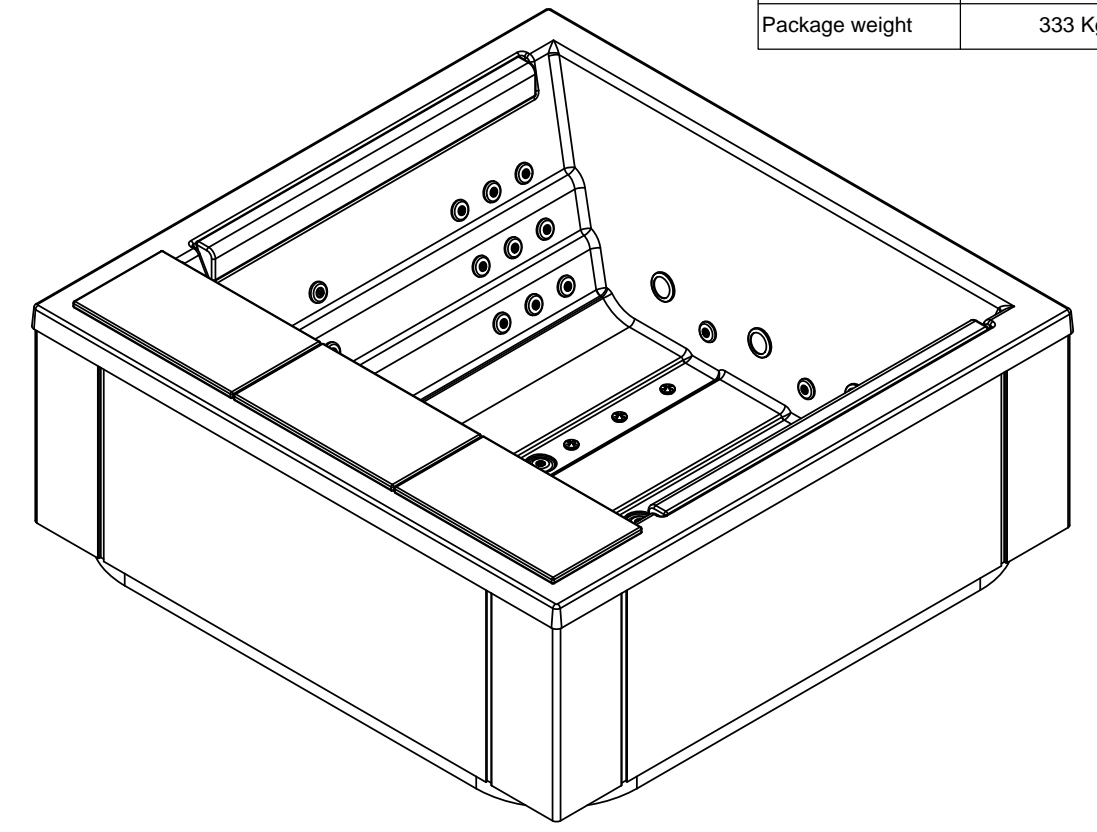
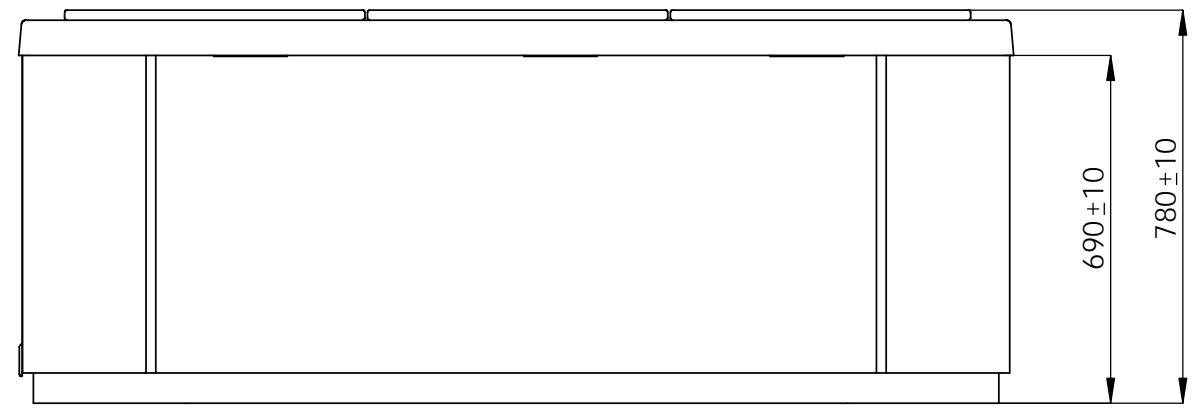
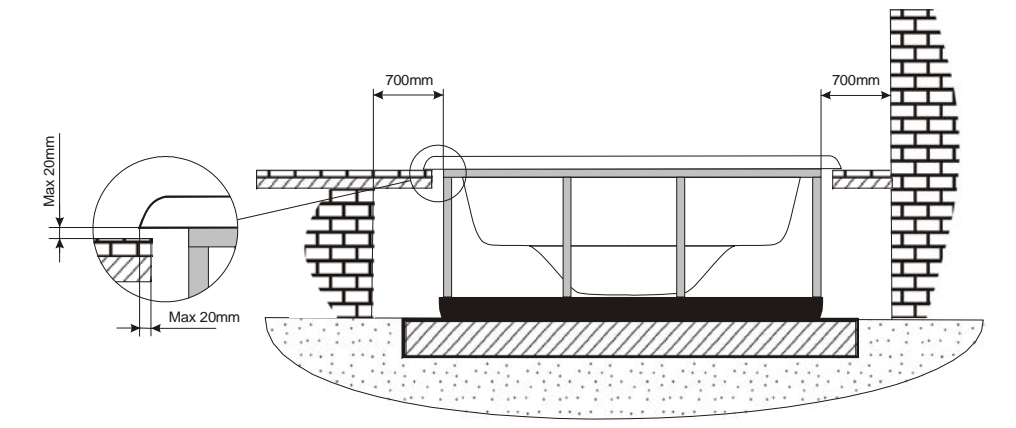

↑ ↑  
ELECTRICAL BOARD CONNECTIONS ACCESS

According to our policy of continuous improvement, dimensions, features or components of this product can be partially or completely changed without prior notice.  
It's Customer responsibility to verify that this is the last version of the drawing

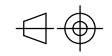
02	26/11/2014	I.Pozo	Add light components and pure line lighting
01	07/10/2014	I.Pozo	Change scale and new spare templates
Change No.	Date	Name	Modification
Remarks			COMMERCIAL
Dimensions in mm. General Tolerances +/- 10mm			
Drawn	06/05/2013	X.Codina	
Checked		I.Nicolas	
Scale	1:15	General Tolerance	Part Number
Sheet	1/2	DIN 7168 ISO 2768g	58748
			Rev.
			02
			First Angle Projection
			
Property of IBERSPA S.L. Avda. Pla d'Urgell 2-8 25200 Cervera, Spain. Don't use without permission. Keep this information confidential and use it solely for the permitted purpose.			

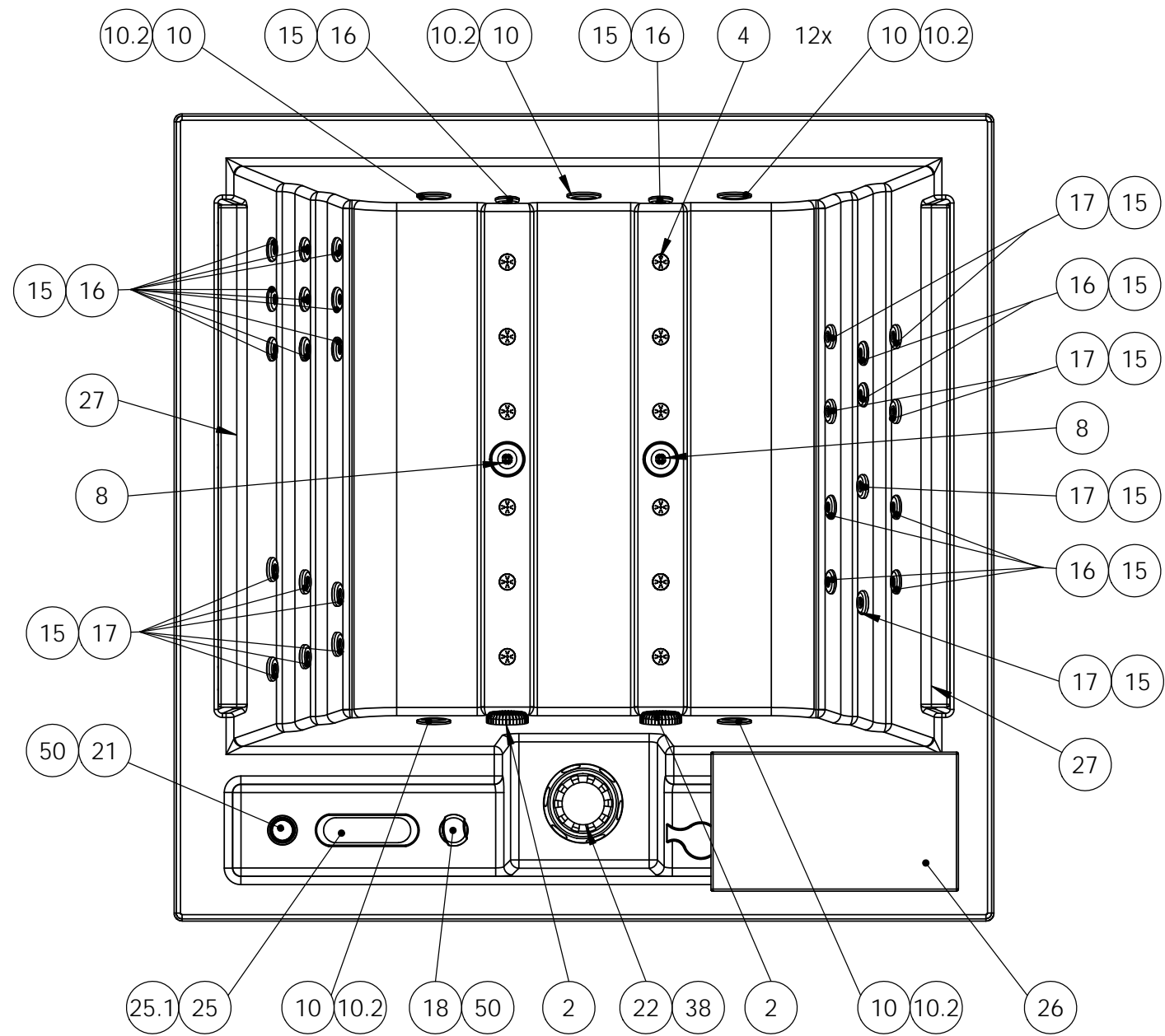

**PUMPS SPARE CODES**

**RPOR0245**  
 MASSAGE PUMP  
 LP250 CV

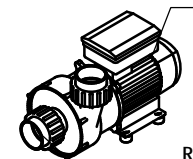

**RPOR0256**  
 UNION NUT+TAILPIECE  
 PUMP LP / WP

**RPOR0244**  
 FILTRATION PUMP JA35  
 0,35CV

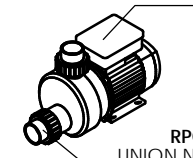

**RPOR0257**  
 UNION NUT+TAILPIECE  
 PUMP JA

**RPOR0274**  
 SPA BLOWER 700 W

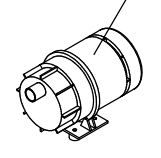

**HEATER AND DESINFECTION SPARE CODES**

**RPOR0191**  
 BOX GS501SZ 1  
 PUMP + BLOWER

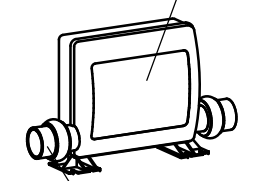

**07816R1013**  
 HEATER RACORDS (2 UNITS)

**RPOR0266**  
 UV DESINFECTION  
 SYSTEM

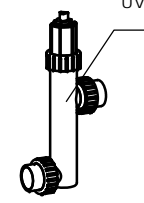

**RPOR0101** - TEMPERATURE PROBES GS I GL (x 2)  
**RPOR0105** - HEATER 3 KW GS I GL  
**RPOR0197** - DIGITAL PANEL GS501SZ

ACCESSORIES			
Position Num.	Part Nº SPARE	Description SPARE	Quant.
2	RPOR0225	GREY SPA DRAIN 2" ADAPTOR SOCKET D.50	2
4	REMP0046	WHITE-STAINLESS STEEL AIR NOZZLE	12
8	RPOR0003	GREY DRAIN SET - BODY+COVER+ASSEMBLY	2
10	RPOR0239	SPOTLIGHT LED SET RD	5
10.2	RPOR0252	LED SLAVE LIGHT	5
15	RPOR0235	JET BODY SET RD 2"	29
16	RPOR0230	FRONTAL JET 2" STAINLESS STEEL DIRECTIONAL	17
17	RPOR0260	JET TWIN ROTO 2" INOX	12
18	RPOR0261	VENTURY CONTROLLER SS	1
21	RPOR0264	AROMA DISPENSER ASM LIT	1
22	RPOR0238	SKIMERFILTER RD LOW PROFILE	1
25	RPOR0195	DIGITAL PANEL VL700+COVER 1 PUMP + BLOWER	1
25.1	RPOR0201	COVER DIGITAL PANEL VL700 1 PUMP + BLOWER	1
26	RPOR0269	TOP COVER CUBE SPA	3
27	RPOR0270	HEADREST CUBE SPA	2
38	RPOR0247	FILTER CARTRIDGE SKIMFILTER RD	1
50	RPOR0267	4 LEDS LIGHTS POINTS	2
70	RPOR0280	LEDS TRANSFORMER 5V DC	1
71	RPOR0281	LEDS CONTROLER	1
73	RPOR0259	CABLE 4 OUTPUTS + LEDS	4

**LIGHT COMPONENTS SPARE CODES**

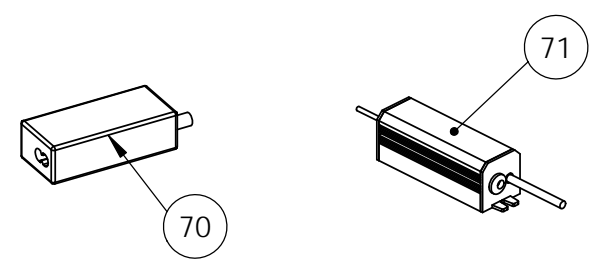

**PURE LINE LIGHTING SPARE CODES**

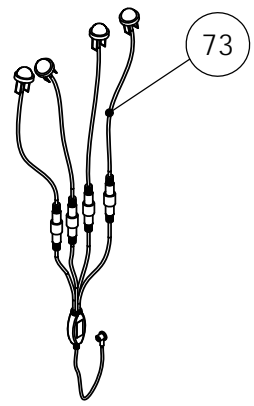

According to our policy of continuous improvement, dimensions, features or components of this product can be partially or completely changed without prior notice. It's Customer responsibility to verify that this is the last version of the drawing

02	26/11/2014	I.Pozo	Add light components and pure line lighting												
01	07/10/2014	I.Pozo	Change scale and new spare templates												
Change No.	Date	Name	Modification												
Remarks															
Dimensions in mm. General Tolerances +/- 10mm															
Drawn	06/05/2013	X.Codina													
Checked		I.Nicolas													
Scale 1:15	General Tolerance DIN 7168 ISO 2768g														
Sheet 2/2			<table border="1"> <tr> <th colspan="4">SPARE PARTS DRAWING</th> </tr> <tr> <td>Part Number</td> <td>Rev.</td> <td>First Angle Projection</td> <td></td> </tr> <tr> <td>58748</td> <td>02</td> <td></td> <td></td> </tr> </table>	SPARE PARTS DRAWING				Part Number	Rev.	First Angle Projection		58748	02		
SPARE PARTS DRAWING															
Part Number	Rev.	First Angle Projection													
58748	02														
Property of IBERSPA S.L. Avda. Pla d'Urgell 2-8 25200 Cervera, Spain. Don't use without permission. Keep this information confidential and use it solely for the permitted purpose.															