

↑                    ↑  
ELECTRICAL BOARD CONNECTIONS ACCESS

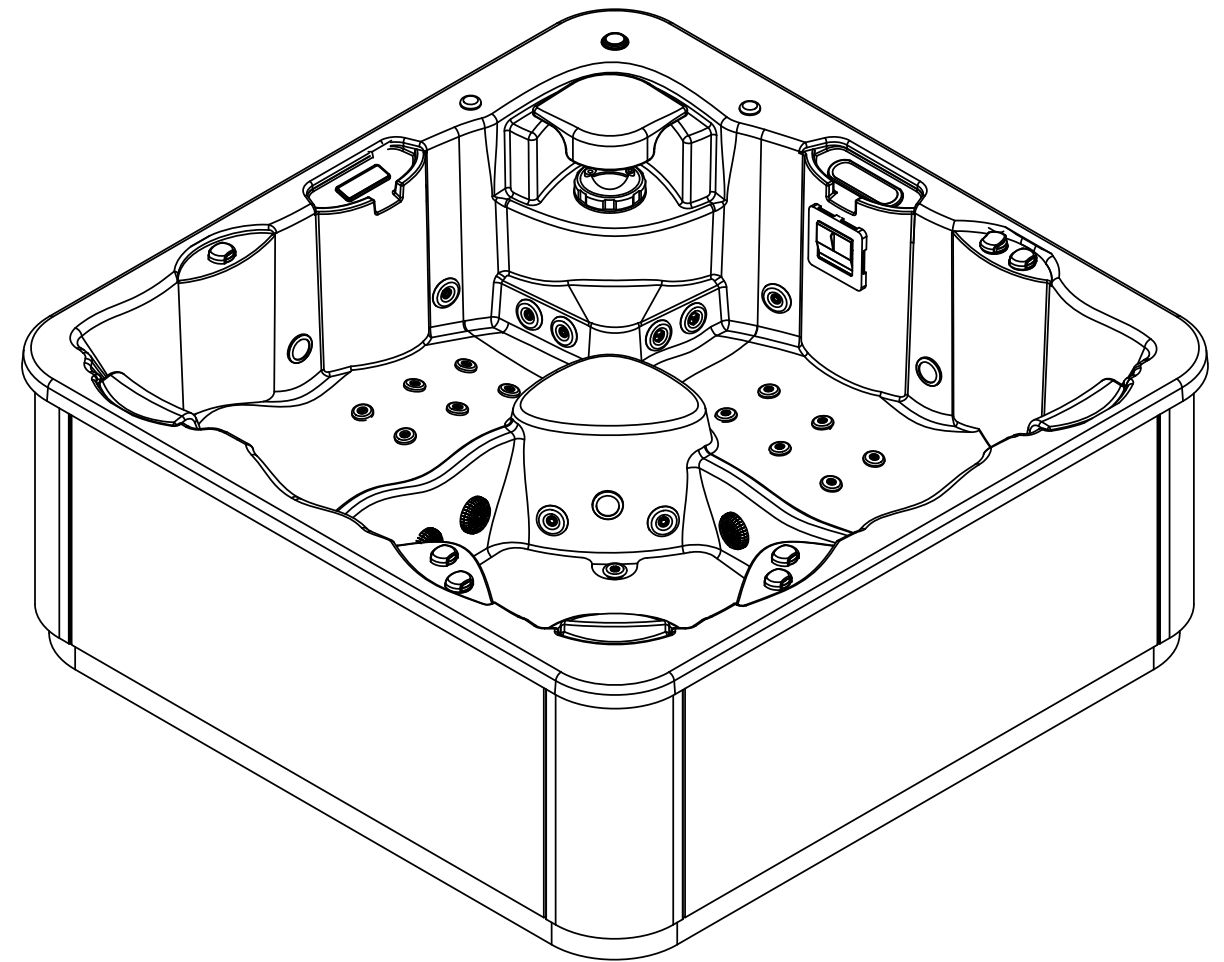

**Inground option**

**WARNING:**  
It's essential to keep a minimum clearance access of **700mm** all around.

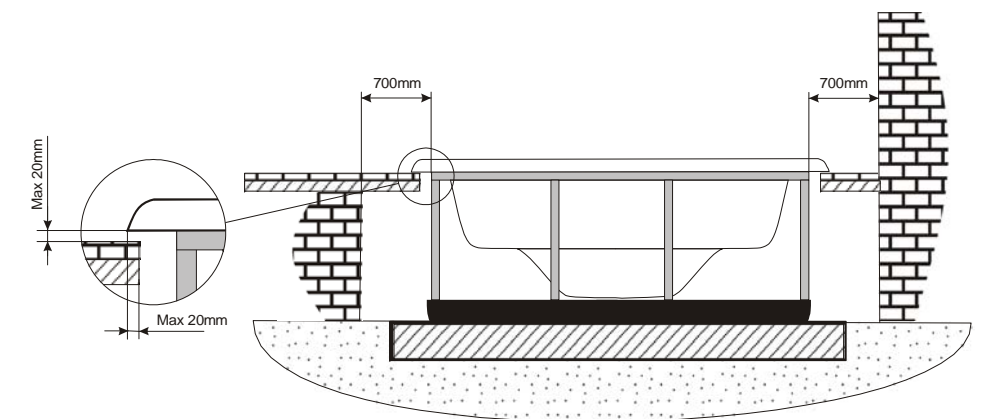

According to our policy of continuous improvement, dimensions, features or components of this product can be partially or completely changed without prior notice.  
It's Customer responsibility to verify that this is the last version of the drawing

06	17/11/2014	I.Pozo	New spare templates
05	25/03/2014	X.Codina	Drawing release
Change No.	Date	Name	Modification
Remarks			<b>COMMERCIAL</b>
Dimensions in mm. General Tolerances +/- 10mm			
Drawn	25/03/2014	X.Codina	
Checked	--	--	
Scale	1:20	General Tolerance DIN 7168 ISO 2768g	
Sheet	1/2		
		Part Number	Rev.
		<b>52666</b>	<b>06</b>
			First Angle Projection 

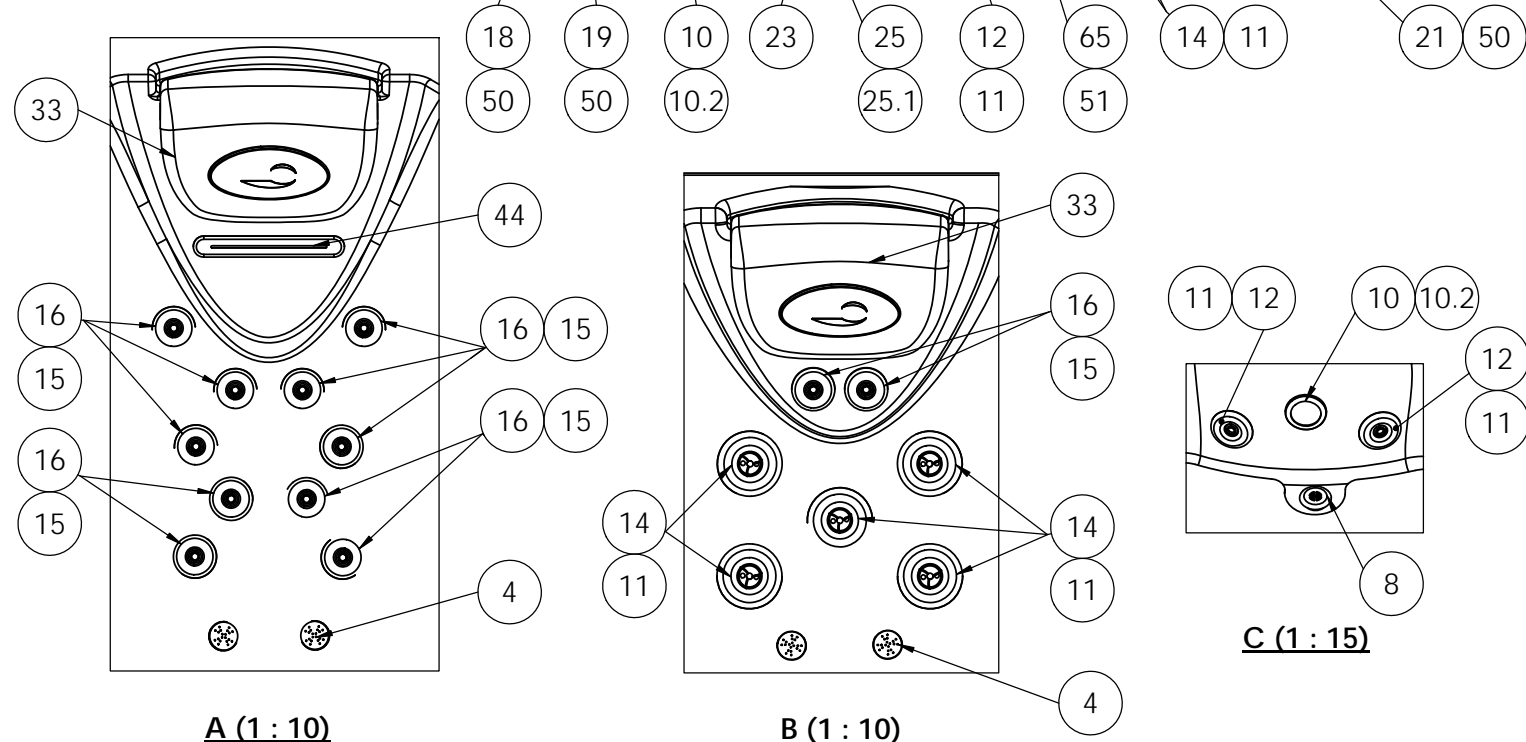
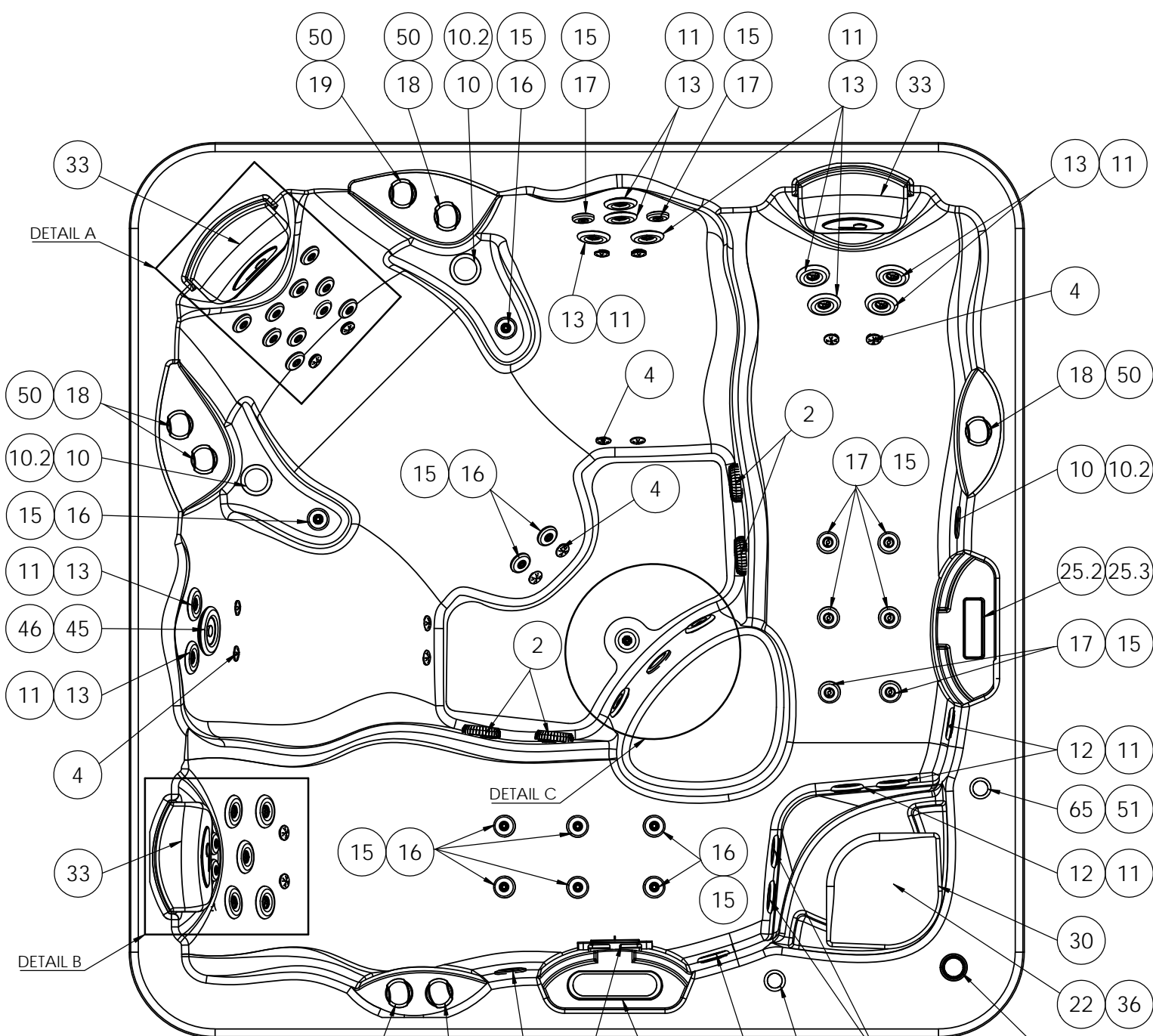

**PUMPS SPARE CODES**

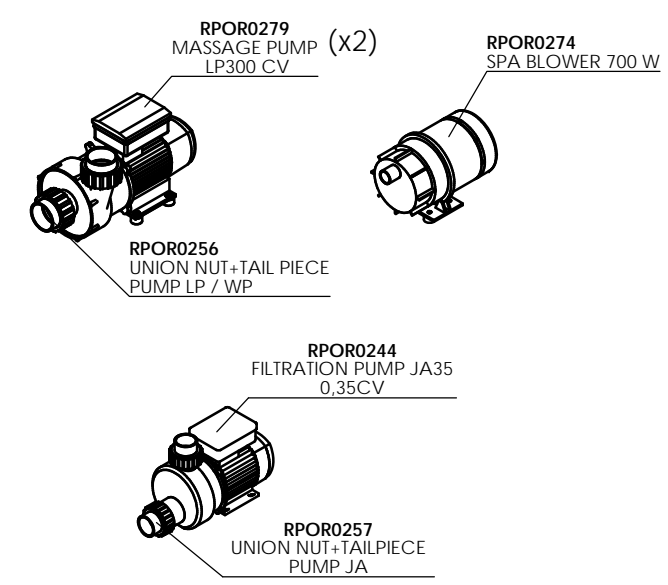

**HEATER AND DESINFECTION SPARE CODES**

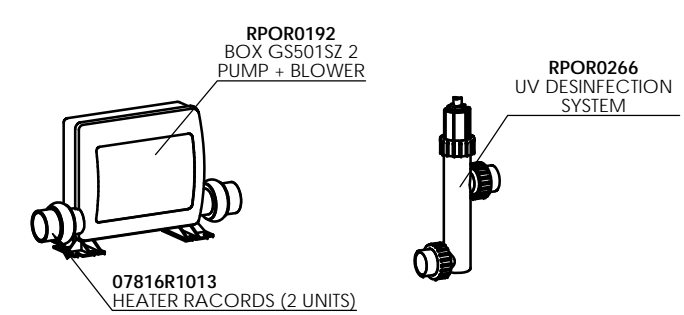

RPOR0101 - TEMPERATURE PROBES GS I GL (x 2)  
 RPOR0105 - HEATER 3 KW GS I GL  
 RPOR0197 - DIGITAL PANEL GS501SZ  
 RPOR0193 - EXPANDER BOARD KIT FOR SISTEM GS501SZ

**PURE LINE LIGHTING SPARE CODES**

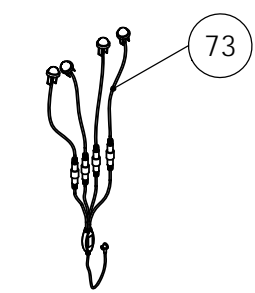

**LIGHT COMPONENTS SPARE CODES**

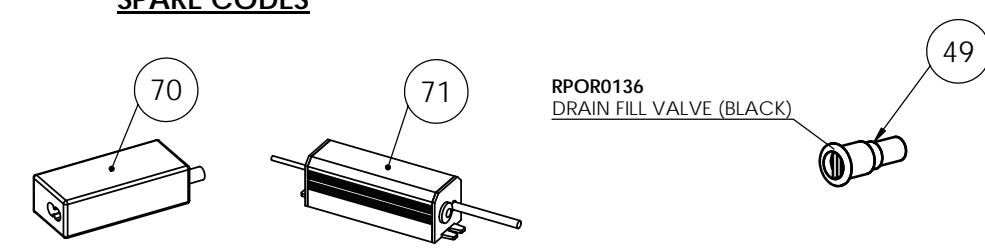

According to our policy of continuous improvement, dimensions, features or components of this product can be partially or completely changed without prior notice. It's Customer responsibility to verify that this is the last version of the drawing

ACCESSORIES			
Position Num.	Part Nº SPARE	Description SPARE	Quant.
2	RPOR0225	GREY SPA DRAIN 2" ADAPTOR SOCKET D.50	4
4	REMP0046	WHITE-STAINLESS STEEL AIR NOZZLE	16
8	RPOR0003	GREY DRAIN SET - BODY+COVER+ASSEMBLY	1
10	RPOR0239	SPOTLIGHT LED SET RD	5
10.2	RPOR0252	LED SLAVE LIGHT	5
11	RPOR0236	JET BODY SET RD 3"	23
12	RPOR0231	FRONTAL JET 3" STAINLESS STEEL DIRECTIONAL	6
13	RPOR0232	FRONTAL JET 3" STAINLESS STEEL 1 JET ROTO	10
14	RPOR0233	FRONTAL JET 3" STAINLESS STEEL TWIN ROTO	7
15	RPOR0235	JET BODY SET RD 2"	30
16	RPOR0230	FRONTAL JET 2" STAINLESS STEEL DIRECTIONAL	22
17	RPOR0260	JET TWIN ROTO 2" INOX	8
18	RPOR0261	VENTURY CONTROLLER SS	5
19	RPOR0263	VALVE ON-OFF 1" SS	2
21	RPOR0264	AROMA DISPENSER ASM LIT	1
22	RPOR0119	PRESSURE FILTER 2"	1
23	RPOR0178	SKIMMER FILTER GRIS for preassure filter	1
25	RPOR0196	DIGITAL PANEL VL700+COVER 2 PUMP + BLOWER	1
25.1	RPOR0202	COVER DIGITAL PANEL VL700 2 PUMP + BLOWER	1
25.2	RPOR0219	AUXILIARY PANEL VL700	1
25.3	RPOR0203	COVER AUXILIARY PANEL VL700	1
30	RPOR0156	SKIMFILTER COVER	1
33	RPOR0094	BIG HEADREST - PACIFIC-ANTARTIC-EVOLUTION	3
36	RPOR0120	PRESSURE FILTER CARTRIDGE	1
44	RPOR0036	GREY WATERFALL	1
45	RPOR0234	FRONTAL JET 5" STAINLESS STEEL DIRECTIONAL	1
46	RPOR0237	JET BODY SET RD 5"	1
49	RPOR0136	DRAIN FILL VALVE (BLACK)	1
50	RPOR0267	4 LEDS LIGHTS POINTS	8
51	RPOR0268	1 LED LIGHT POINT	2
65	RPOR0284	FOUNTAIN POP-UP	2
70	RPOR0280	LEDS TRANSFORMER 5V DC	1
71	RPOR0281	LEDS CONTROLER	1
73	RPOR0259	CABLE 4 OUTPUTS + LEDS	4

06	17/11/2014	I.Pozo	New spare templates												
05	25/03/2014	X.Codina	Drawing release												
Change No.	Date	Name	Modification												
Remarks Dimensions in mm. General Tolerances +/- 10mm															
Drawn	25/03/2014	X.Codina													
Checked	--	--													
Scale 1:15	General Tolerance DIN 7168 ISO 2768g														
Sheet 2/2			<table border="1"> <tr> <th colspan="4">SPARE PARTS DRAWING</th> </tr> <tr> <td>Part Number</td> <td>Rev.</td> <td>First Angle Projection</td> <td></td> </tr> <tr> <td>52666</td> <td>06</td> <td></td> <td></td> </tr> </table>	SPARE PARTS DRAWING				Part Number	Rev.	First Angle Projection		52666	06		
SPARE PARTS DRAWING															
Part Number	Rev.	First Angle Projection													
52666	06														
Property of IBERSPA S.L. Avda. Pla d'Urgell 2-8 25200 Cervera, Spain. Don't use without permission. Keep this information confidential and use it solely for the permitted purpose.															